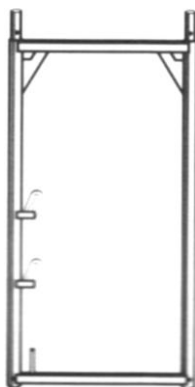
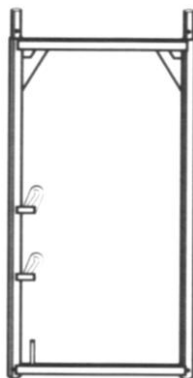

STANDARD RAMME
aluminium

Høyde x Bredd (m)	Kg	Art. nr.	Pris
2,00x0,73	8,9	E282220	869.-
1,50x0,73	7,5	E282215	812.-
1,00x0,73		E282210	659.-
0,66x0,73	4,4	E282206	583.-

STANDARD RAMME
stål

Høyde x Bredd (m)	Kg	Art. nr.	Pris
2,00x0,73	22,0	E281620	636.-
1,50x0,73	18,4	E281615	603.-
1,00x0,73	13,4	E281610	577.-
0,66x0,73	10,9	E281606	532.-

REKKVERK RAMME

aluminium, for øverste plattengende

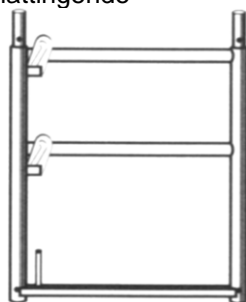

Høyde x Bredd (m)	Kg	Art. nr.	Pris
1,00x0,73	7,0	E288107	705.-

REKKVERK STØTTE

aluminium, for øverste rekkverk

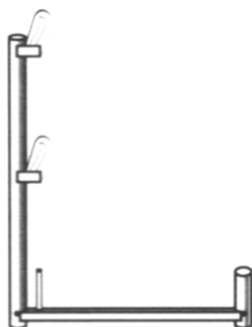

Høyde x Bredd (m)	Kg	Art. nr.	Pris
1,00x0,73	3,3	E287007	391.-

Med forbehold om feil i priser og data. Alle prisene er eks. mva. og gjelder 8/3-010

DELTA SYSTEM AS - HOVEDKONTOR: Storebotn Næringspark • 5300 Kleppestø • NORWAY • Tel: +47 55 70 70 54 • Fax: +47 56 15 02 01 • firmapost@deltasystem.no

DELTA SYSTEM AS - ØSTLANDET: Heiasvingen 40 • 1900 Fettsund • NORWAY • Tel: +47 9949 0601 • Fax: +47 5615 0201 • firmapost@deltasystem.no

REKKVERK STØTTE

aluminium, enkel, for øverste rekkverk

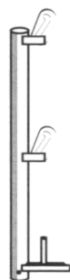

Høyde (m)	Kg	Art. nr.	Pris
1,00	1,5	E282800	325.-

REKKVERK STØTTE

stål, enkel, for øverste rekkverk

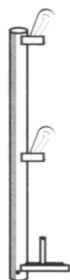

Høyde (m)	Kg	Art. nr.	Pris
1,00	4,5	E282700	225.-

STØTTERAMME FOR NETTING

stål

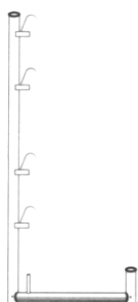

Høyde x Bredde (mm)	Kg	Art. nr.	Pris
2,00x1,09	15,3	E285910	610.-
2,00x0,73	13,8	E285907	567.-

BUNNRAMME FOR RULLESTILLAS

stål

Brukes når rammestillas bygges som rullestillas



Benevnelse	Kg	Art. nr.	Pris
Ramme bunn	26,3	E571173	1 351.-

Med forbehold om feil i priser og data. Alle prisene er eks. mva. og gjelder 8/3-010

DELTA SYSTEM AS - HOVEDKONTOR: Storebotn Næringspark • 5300 Kleppestø • NORWAY • Tel: +47 55 70 70 54 • Fax: +47 56 15 02 01 • firmapost@deltasystem.no

DELTA SYSTEM AS - ØSTLANDET: Heiasvingen 40 • 1900 Fetsund • NORWAY • Tel: +47 9949 0601 • Fax: +47 5615 0201 • firmapost@deltasystem.no

DOBBELTREKKVERK

aluminium

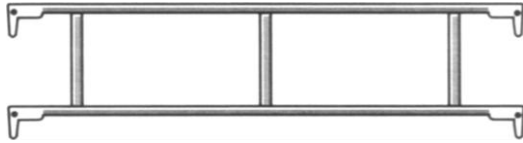

Lengde (m)	Kg	Art. nr.	Pris
3,07	6,9	E284330	671.-
2,57	5,9	E284325	557.-
2,07	5,0	E284320	531.-
1,57	4,0	E284315	411.-

DOBBELTREKKVERK, ENDE

stål



Bredde (m)	Kg	Art. nr.	Pris
1,09	5,1	E283910	238.-
0,73	3,9	E283907	226.-

ENKELTREKKVERK

stål



Lengde	Kg	Art. nr.	Pris
3,07	5,7	E283630	166.-
2,57		E283625	139.-
2,07	4,0	E283620	133.-
1,57	3,1	E283615	126.-

PLATTING

aluminium m/ kryssfiner



Lengde x Bredde (m)	Kg	Art. nr.	Pris
3,07x0,61	24,0	E491130	1 458.-
2,57x0,61	20,8	E491125	1 125.-
2,07x0,61	17,9	E491120	1 017.-
1,57x0,61	14,7	E491115	901.-

PLATTING

aluminium m/Lutek plate (kompositt)



Lengde x Bredde (m)	Kg	Art. nr.	Pris
3,07x0,61	20,1	RL491130	2 212.-
2,57x0,61	13,7	RL491125	1 774.-
2,07x0,61	10,9	RL491120	1 483.-
1,57x0,61	8,5	RL491115	1 420.-

LUKEPLATTING

aluminium / kryssfiner, m/stige

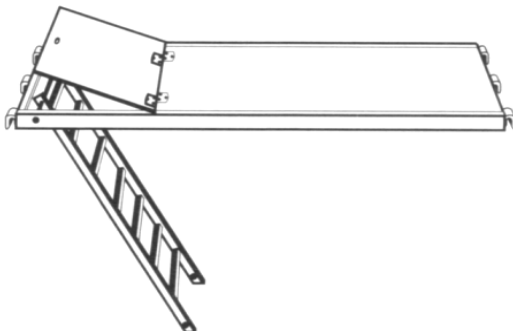

Lengde x Bredde (m)	Kg	Art. nr.	Pris
3,07x0,61	30,7	E492330	2 284.-
2,57x0,61	27,7	E492325	2 104.-

Med forbehold om feil i priser og data. Alle prisene er eks. mva. og gjelder 8/3-010

LUKEPLATTING

aluminium og Lutek plate (kompositt), m/stige

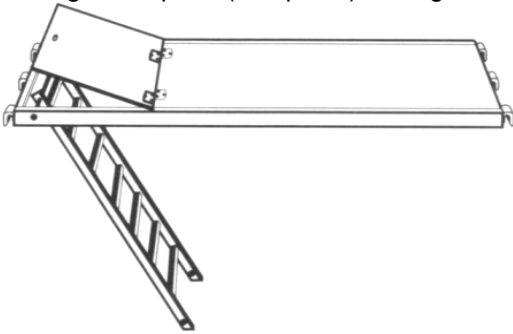

Lengde x bredde (m)	Kg	Art. nr.	Pris
3,07x0,61	25,0	L492330	3 369.-
2,57x0,61		L492325	2 886.-

LUKEPLATTING

aluminium / kryssfiner, u/stige

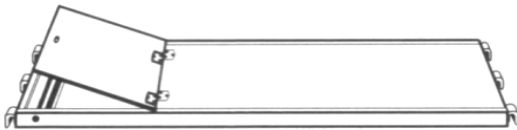

Lengde x Bredd (m)	Kg	Art. nr.	Pris
3,07x0,61	26,1	E492830	1 874.-
2,57x0,61	22,3	E492825	1 716.-
2,07x0,61	20,2	E492820	1 566.-

LUKEPLATTING

stål

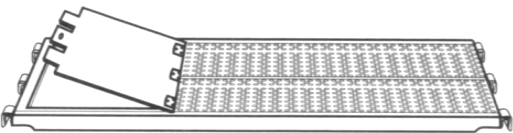

Lengde x Bredd (m)	Kg	Art. nr.	Pris
2,57x0,64	39,6	E492425	1 849.-

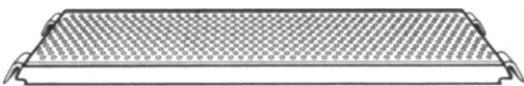
STÅLPLATTING

Lengde x Bredd (m)	Kg	Art. nr.	Pris
3,07x0,32	20,5	E491330	591.-
2,57x0,32	17,4	E491325	522.-
2,07x0,32	14,2	E491320	480.-
1,57x0,32	11,1	E491315	424.-
1,09x0,32	8,0	E491310	410.-
0,73x0,32	5,8	E491307	

STÅLPLATTING

med ekstra avstiving

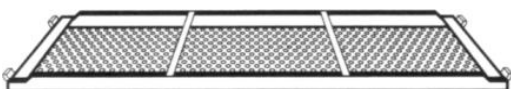

Lengde x Bredd (m)	Kg	Art. nr.	Pris
3,07x0,32	22,2	E491430	613.-
2,57x0,32	18,9	E491425	543.-
2,07x0,32	15,5	E491420	500.-
1,57x0,32	12,1	E491415	446.-

Med forbehold om feil i priser og data. Alle prisene er eks. mva. og gjelder 8/3-010

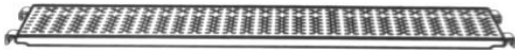
STÅLPLATTING
 til utligning

Lengde x Bredde (m)	Kg	Art. nr.	Pris
3,07x0,16	16,9	E491230	
2,57x0,16	14,3	E491225	516.-
2,07x0,16	11,6	E491220	473.-
1,57x0,16	9,0	E491215	418.-

BUNNSKRUE
 stål

Diam. x Høyde (mm)	Kg	Art. nr.	Pris
38x600	4,8	ST1003	211.-

BUNNSKRUE LEDDET
 stål

Diam. x Høyde (mm)	Kg	Art. nr.	Pris
38x800	7,8	E511408	501.-

BUNNSKRUE
 m/2 spindler

Diam. x Høyde (mm)	Kg	Art. nr.	Pris
38x600	4,1	E571175	229.-

HJUL MED BREMS
 kompakt gummi

Diam. x Høyde (mm)	Kg	Art. nr.	Pris
38x600		ST1014	
32x600	16,5	ST1012	1 656.-

Med forbehold om feil i priser og data. Alle prisene er eks. mva. og gjelder 8/3-010

FOTPLATE

Høyde (m)	Kg	Art. nr.	Pris
0,15	1,3	E511200	96.-

DIAGONALSTAG

stål, m/skru klips



Benevnelse	Kg	Art. nr.	Pris
3,07m felt	8,3	E284730	226.-
2,57m felt	7,4	E284725	202.-
2,07m felt	6,6	E284720	199.-

DIAGONALSTAG

stål, m/kileklips



Benevnelse	Kg	Art. nr.	Pris
3,07m felt	8,5	E284830	244.-
2,57m felt	7,6	E284825	229.-
2,07m felt	6,8	E284820	

DIAGONALSTAG

stål, for konsoll

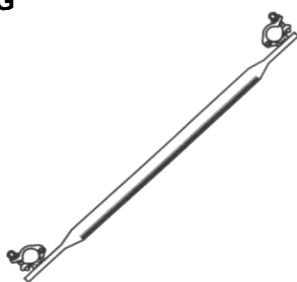

Lengde (m)	Kg	Art. nr.	Pris
1,95	8,8	E285119	365.-
1,77	8,2	E285179	332.-

AVSTIVING

stål, horisontal



Lengde (m)	Kg	Art. nr.	Pris
3,07	10,4	E283830	578.-
2,57	8,9	E283825	498.-
2,07	7,4	E283820	434.-

Med forbehold om feil i priser og data. Alle prisene er eks. mva. og gjelder 8/3-010

DELTA SYSTEM AS - HOVEDKONTOR: Storebotn Næringspark • 5300 Kleppestø • NORWAY • Tel: +47 55 70 70 54 • Fax: +47 56 15 02 01 • firmapost@deltasystem.no

DELTA SYSTEM AS - ØSTLANDET: Heiasvingen 40 • 1900 Fettsund • NORWAY • Tel: +47 9949 0601 • Fax: +47 5615 0201 • firmapost@deltasystem.no

FOTLIST

tre

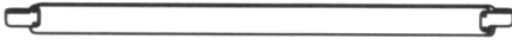

Lengde x Høyde (m)	Kg	Art. nr.	Pris
3,07x0,15		E286830	166.-
2,57x0,15	6,1	E286825	136.-
2,07x0,15	4,7	E286820	129.-
1,57x0,15	3,1	E286815	126.-

ENDEFOTLIST

tre, platingBREDD



Lengde x Høyde (m)	Kg	Art. nr.	Pris
1,09x0,15	2,3	E286810	90.-
0,73x0,15	2,0	E286807	76.-

VEGGFESTE (STAG, KLEMME, ØYEBOLT)

stål



Benevnelse	Kg	Art. nr.	Pris
STAG 1,00m	1,0	ST1072	60.-
STAG 0,80m	0,9	ST1073	45.-
STAG 0,60m	0,7	ST1074	43.-
KLEMME	0,6	ST1070	67.-
ØYEBOLT	0,1	ST1127	17.-

VEGGFESTE

stål, rør + klips fast



Lengde (m)	Kg	Art. nr.	Pris
1,30	4,5	E2865135	116.-
1,00	4,2	ST2085	110.-
0,80	4,0	E2865085	101.-
0,45	1,7	E286504	57.-
Klips fast	1,3	ST1021	47.-

LÅSEBØYLE

stål



Benevnelse	Kg	Art. nr.	Pris
Låsebøyle	0,1	E511100	6.-

STIGE

stål, for lukeplating

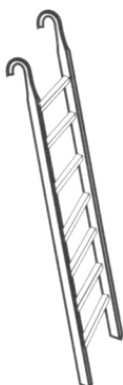

Lengde x Bredde (m)	Kg	Art. nr.	Pris
2,15x0,35	10,8	E511600	434.-

Med forbehold om feil i priser og data. Alle prisene er eks. mva. og gjelder 8/3-010

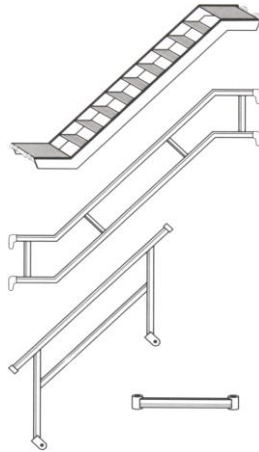
TRAPPEOPPGANGER
aluminium

Benevnelse (m)	Kg	Art. nr.	Pris
Trapp 3,07	29,9	E286230	3 966.-
Trapp 2,57	25,1	E286225	3 063.-
Utvendig rekkverk for trapp 3,07	17,8	E286330	1 038.-
Utvendig rekkverk for trapp 2,57	16,0	E286325	1 004.-
Innvendig rekkverk for trapp	12,8	E286300	1 131.-
U-riegel Festes på bunnskruer	3,0	E286207	282.-

KONSOLL

stål, for utvidelse av stillas i bredden

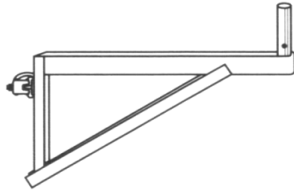

Høyde x Bredder (m)	Kg	Art. nr.	Pris
2,00x0,73	19,5	E285589	567.-
0,37x0,73	6,3	E285579	349.-
0,20x0,36	3,4	E285539	209.-

KONSOLL FOR HEISHJUL

heis



aluminium



stål



stål

stål

Benevnelse	Kg	Art. nr.	Pris
Heiskonsoll, stål	8,0	ST1015	556.-
Heiskonsoll, alu for rammestillas	4,2	ST1009	730.-
Hjul, stål for heiskonsoll	2,7	ST1017	1 486.-
Sjakkell, stål	0,4	ST1055	

KONSOLL

knekt for overdekking

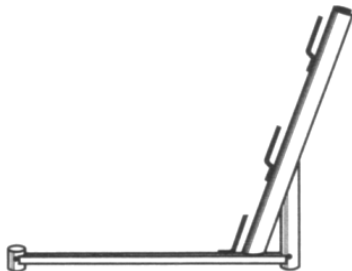

Bredden (m)	Kg	Art. nr.	Pris
0,73	6,0	E288501	282.-

Med forbehold om feil i priser og data. Alle prisene er eks. mva. og gjelder 8/3-010

DELTA SYSTEM AS - HOVEDKONTOR: Storebotn Næringspark • 5300 Kleppestø • NORWAY • Tel: +47 55 70 70 54 • Fax: +47 56 15 02 01 • firmapost@deltasystem.no

DELTA SYSTEM AS - ØSTLANDET: Heiasvingen 40 • 1900 Fetsund • NORWAY • Tel: +47 9949 0601 • Fax: +47 5615 0201 • firmapost@deltasystem.no

NETTING GITTER

stål, ved takarbeid

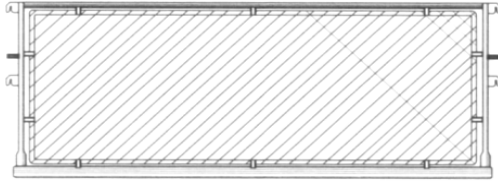

Lengde x bredde (m)	Kg	Art. nr.	Pris
3,07x1,00	27,4	E285030	1 004.-
2,57x1,00	23,7	E285025	871.-
2,07x1,00	20,1	E285020	805.-
1,57x1,00	16,5	E285015	742.-

DRAGER

stål, utveksling



Lengde x Bredde (m)	Kg	Art. nr.	Pris
6,14x0,45	62,1	E287761	2 009.-
5,14x0,45	56,0	E287751	1 745.-

DRAGER

aluminium, fagverk + skjøtestuss

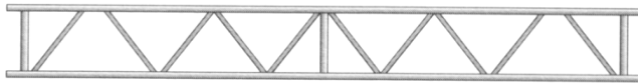

stål

Lengde (m)	Kg	Art. nr.	Pris
8,24	34,4	R50800	3 137.-
6,24	26,4	R50600	2 720.-
5,24	22,6	R50500	2 368.-
4,24	18,8	R50400	1 999.-
SKJØTESTUSS	2,2	R50000	

U-PROFIL / TVERRIEGEL

aluminium



Sammen med E287751 og E287761

Lengde (m)	Kg	Art. nr.	Pris
0,73	2,8	E503407	310.-

U-PROFIL / TVERRIEGEL

stål, m/klips

Brukes som ekstra opplegg for plattning



Lengde (m)	Kg	Art. nr.	Pris
0,73	3,3	E285379	349.-
1,09	6,0	E285319	377.-

TRAVERS

aluminium, lang, for plattning

Til bruk på fagverksdragere for å legge plank på



Benevnelse	Kg	Art. nr.	Pris
2. plattning	2,7	E501064	286.-
3. plattning		E501096	332.-
4. plattning	3,8	E501018	295.-
5. plattning	5,2	E501010	456.-
6. plattning	3,8	E501012	
3m drager	8,5	E501039	697.-
4m drager	10,2	E501049	871.-
5m drager	12,7	E501059	1 440.-
6m drager	15,2	E501069	1 325.-

Med forbehold om feil i priser og data. Alle prisene er eks. mva. og gjelder 8/3-010

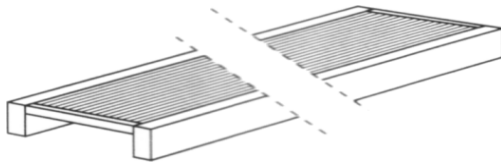
GANGVEI
 aluminium

Lengde x Bredde (m)	Kg	Art. nr.	Pris
7,10x0,59	52,5	E491071	
6,15x0,59	46,0	E491061	5 629.-
5,20x0,59	39,0	E491052	4 878.-

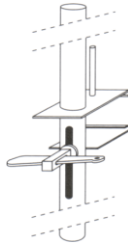
REKKVERK FESTESTANG
 stål

Benevnelse	Kg	Art. nr.	Pris
Rekkverk festestang	2,5	E491001	442.-

KLIPS FAST 49/49
 stål

Benevnelse	Kg	Art. nr.	Pris
Klips fast	1,3	ST1021	47.-

KLIPS VRIDBAR 49/49
 stål



Benevnelse	Kg	Art. nr.	Pris
Klips vridbar		ST1026	53.-

T-BOLT M22
 stål

Mål (mm)	Kg	Art. nr.	Pris
140 x 70	0,1	ST1065	16.-

T-MUTTER M22
 stål

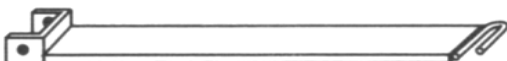
Mål (mm)	Kg	Art. nr.	Pris
Ø 18	0,0	ST1067	6.-

PLATTING SIKRING
 stål

Lengde x Bredde (m)	Kg	Art. nr.	Pris
1,09	2,3	E285410	97.-
0,73	1,5	E285407	87.-
0,36	0,9	E285403	70.-

Med forbehold om feil i priser og data. Alle prisene er eks. mva. og gjelder 8/3-010

LAGERTAINER

stål, 1,5m

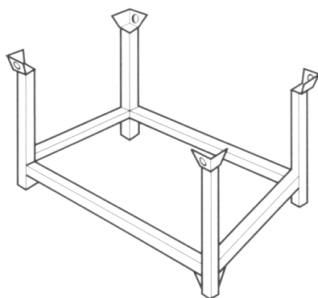

Lengde x Brekke (m)	Kg	Art. nr.	Pris
1,20x0,90	41,0	ZBM-523	1 151.-
Forsterket 1,20x0,90	47,5	ZBM-566	1 326.-

LAGERTAINER KORG

stål, til ZBM-566, for små stillasdelar

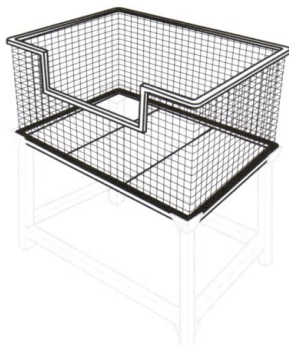

Lengde x Brekke (m)	Kg	Art. nr.	Pris
1,04x0,90	40,4	ZBM-567	1 479.-

REKKVERK FESTE

stål



Benevnelse	Kg	Art. nr.	Pris
Rekkverk feste	0,4	E491002	52.-

FORTAUSRAMME

stål, for fotgjengerundergang

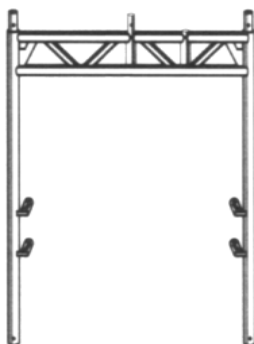

Høyde x Brekke (m)	Kg	Art. nr.	Pris
2,20x1,50	35,9	E281515	1 446.-

Med forbehold om feil i priser og data. Alle prisene er eks. mva. og gjelder 8/3-010

DELTA SYSTEM AS - HOVEDKONTOR: Storebotn Næringspark • 5300 Kleppestø • NORWAY • Tel: +47 55 70 70 54 • Fax: +47 56 15 02 01 • firmapost@deltasystem.no

DELTA SYSTEM AS - ØSTLANDET: Heiasvingen 40 • 1900 Fettsund • NORWAY • Tel: +47 9949 0601 • Fax: +47 5615 0201 • firmapost@deltasystem.no

SKRALLE



Benevnelse	Kg	Art. nr.	Pris
Skralle	0,5	ST1010	609.-

KLAMMER

stål



Benevnelse	Kg	Art. nr.	Pris
Klammer	0,3	E491003	116.-

REKKVERK KILEFESTE

stål

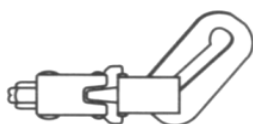

Benevnelse	Kg	Art. nr.	Pris
Rekkverk kilefeste		E284600	116.-

STILKON HOLDER / KORT



Benevnelse	Kg	Art. nr.	Pris
STL holder	0,1	ST1076	71.-
STL kort	0,1	ST1077	41.-

Med forbehold om feil i priser og data. Alle prisene er eks. mva. og gjelder 8/3-010

DELTA SYSTEM AS - HOVEDKONTOR: Storebotn Næringspark • 5300 Kleppestø • NORWAY • Tel: +47 55 70 70 54 • Fax: +47 56 15 02 01 • firmapost@deltasystem.no

DELTA SYSTEM AS - ØSTLANDET: Heiasvingen 40 • 1900 Fetsund • NORWAY • Tel: +47 9949 0601 • Fax: +47 5615 0201 • firmapost@deltasystem.no























